



# BLIND HINGED DOOR

General Information	
description	blind, double leaf, hinged door
type	B15DHB2
manufacturer	Blu Bud srl
Application	
fire properties	B15 Class fire resistant
certificates, approvals	RINA MED Module B Nr. MED066315CS
drawing number	B15DHB2
Size	
max horizontal clear opening (LNO)	2200 mm
max vertical clear opening (LNV)	2100 mm
horizontal cut in bulkhead (TPO)	LNO + 80 mm + 10 mm
vertical cut in bulkhead (TPV)	LNV + sill height + over door panel + 5 mm
sill	25 mm
Frame	
section shape	L or T or Z
section size	50x20 mm
thickness of steel	1,2mm
materials	steel or stainless steel (ss)
finishing	raw, paint, brushed or polished (ss)
counter frame thickness	0,8mm
Leaf	
concept	sandwich
thickness	40mm
core	one layer of mineral wool
material of skins	steel or stainless steel (ss)
coating	raw, laminates, PVC, brushed or polished (ss)
leaf frame	paint, brushed or polished (ss)
Accessories	
standard	hinges, lockcase, caps, sill cover
extra	lockset, <b>concealed door closer</b> , <b>concealed hinges</b> , door stopper, <b>gaskets</b> , nr. 2 windows, ventilation grill, spy
window size	310mm (w) x 310mm (h)
ventilation grill size	380mm (w) x 190mm (h)
Mechanical and physical properties	
noise reduction	n.a.

Product data sheet

B15\_hinged\_door\_type\_B15DHB2

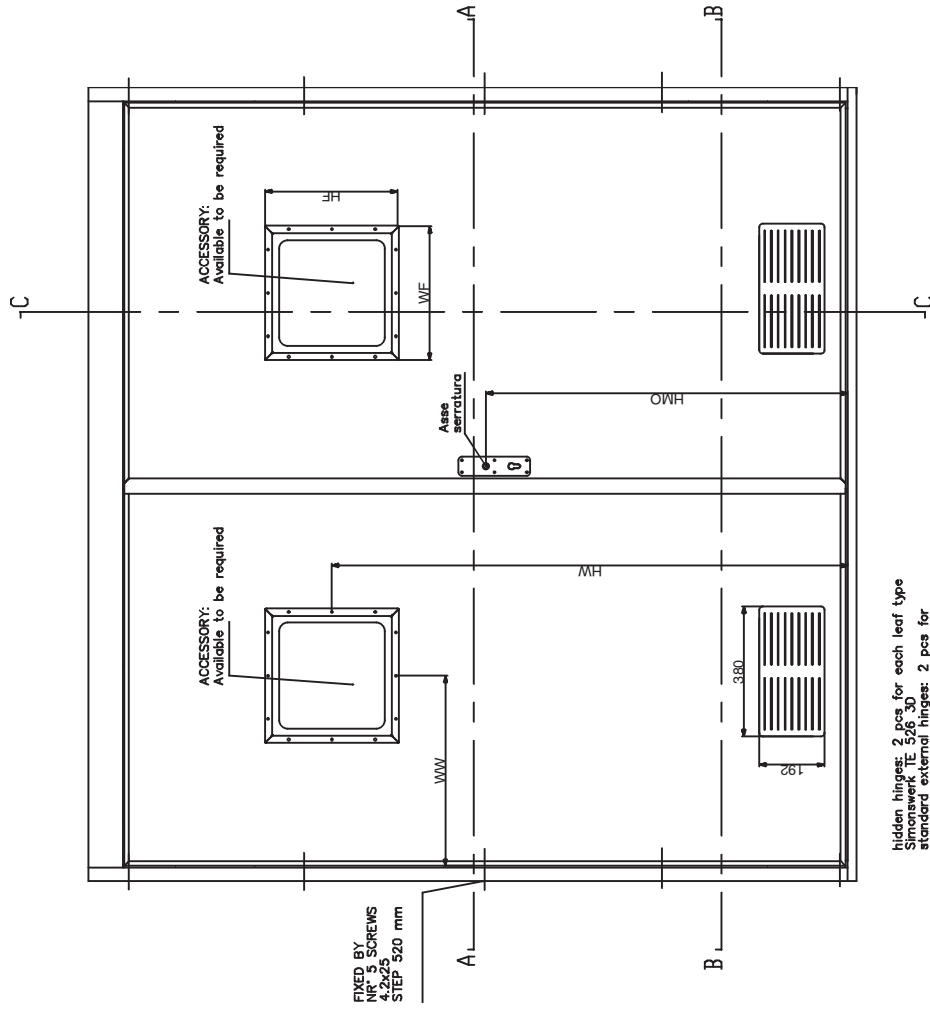

FIXED BY  
 NR. 5 SCREWS  
 4.2x25  
 STEP 520 mm

Hidden hinges: 2 pcs for each leaf type  
 Simonwerk TE 526, 3D  
 standard external hinges: 2 pcs for  
 each leaf

ACCESSORY:  
 Available to be required

ACCESSORY:  
 Available to be required

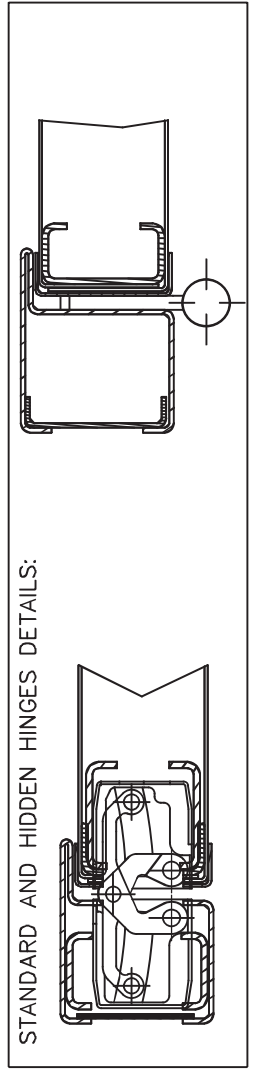

STANDARD AND HIDDEN HINGES DETAILS:

DETAIL 2  
 SCALE 1:2

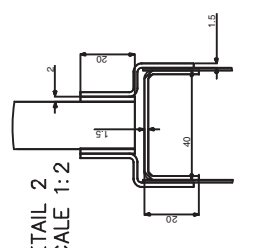

ACCESSORY:  
 Available to be required

OPTIONAL GASKET

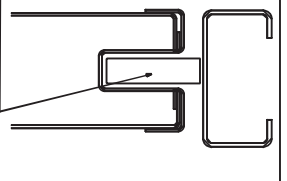

DETAIL 4  
 SCALE 1:2

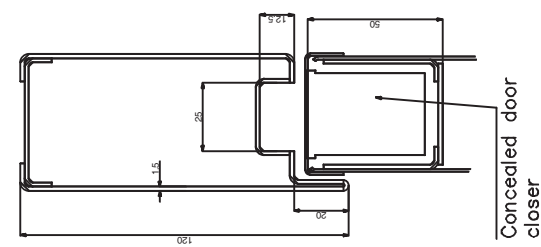

Concealed door  
 closer

OPTIONS

1

2

3

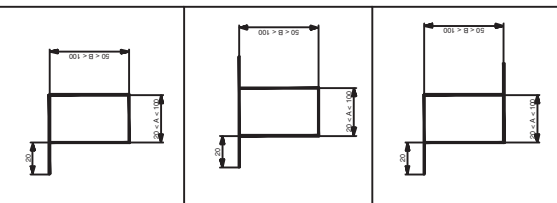

DETAIL 1  
 SCALE 1:2

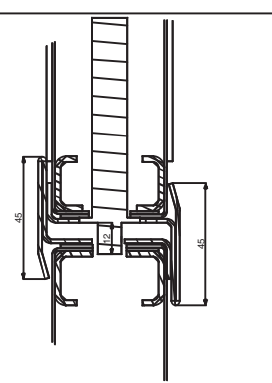

OPTIONS DETAIL HS SCALE 1:2

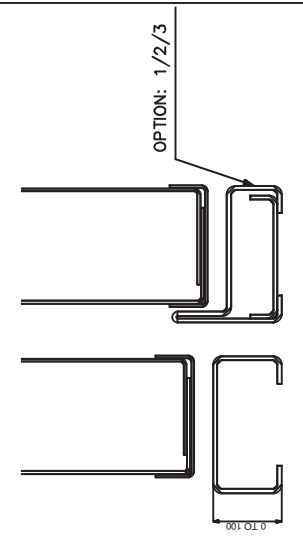

REV.	DATA / DATE	DESCRIZIONE DELLE MODIFICHE / DESCRIPTION OF ALTERATIONS	Controllato / Modified	Checked	Revised
Riferimento / Reference	BLUBUD srl	DESCRIZIONE DELLE MODIFICHE / DESCRIPTION OF ALTERATIONS			
Descrizione / Description	BLUBUD srl				
Materiale / Material	Operational office: 16128 Genova - ITALY Tel. +39. 010. 8601 379 Fax. +39. 010. 8183 053	Scala / Scale	1:16	Data / Date	24/03/2015
Spessore / Thickness	Nota / Note	Controllato da / Checked by	P.M.	Disegnato da / Drawn by	M.M.
Net Weight Kg	Net Weight Kg	Classificato / Classified	P.M.	Disegnato da / Drawn by	M.M.
Tolleranza Generale / General Tolerance	1/1	Classe prodotto / Product Class	http://www.blubud.it	Tipologia / Typology	B15DHB2
Questo disegno non può essere usato o riprodotto senza nostra autorizzazione / This drawing cannot be copied, duplicated or disclosed without our permission					



BLUBUD srl  
 Sede operativa:  
 Operational office:  
 16128 Genova - ITALY  
 Tel. +39. 010. 8601 379  
 Fax. +39. 010. 8183 053  
 Sede legale:  
 Via Fieschi 209  
 16121 Genova Italy  
 e-mail: info@blubud.it

BLUBUD srl TECHNICAL OFFICE

B15 Blind Hinged Door - B15DHB2