

INSTALLATION ACCESSORIES

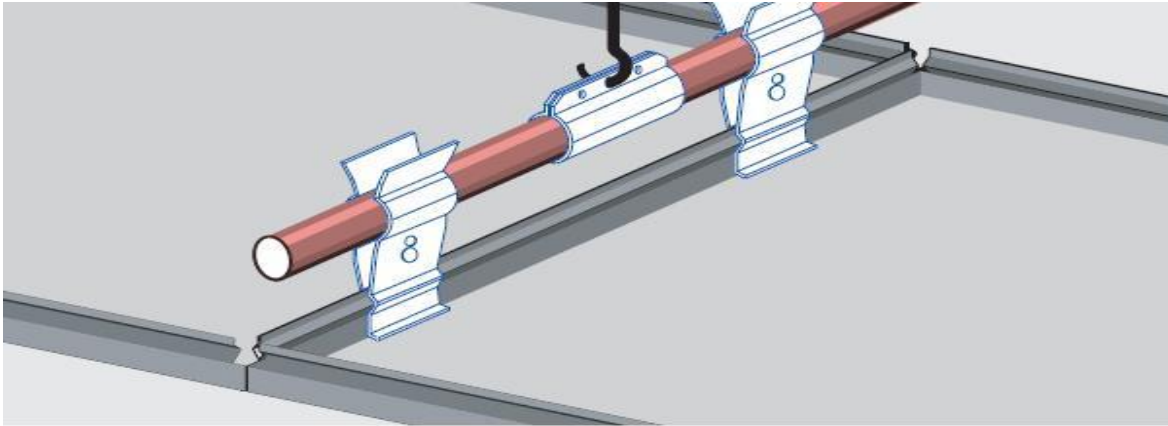

General Information	
description	light box
type	ACC030
manufacturer	Prometal S.p.A.
Structure	
weight	-
material	galvanized steel
finishing	rough
size	see dwg
thickness	see dwg
Use installation	
light box ceiling panel type	shape 180B

Product data sheet

installation_type_ACC030_rev00

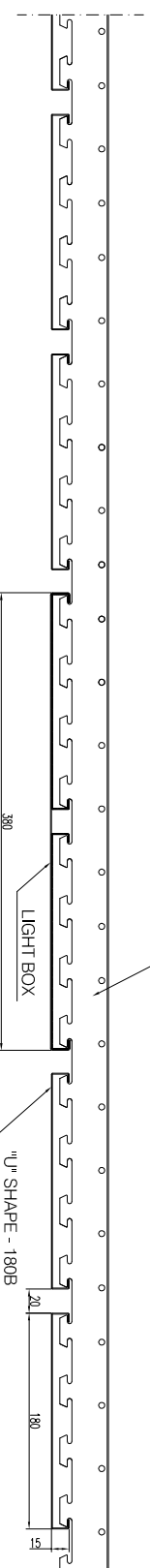

A-A SECTION
scale 1:4

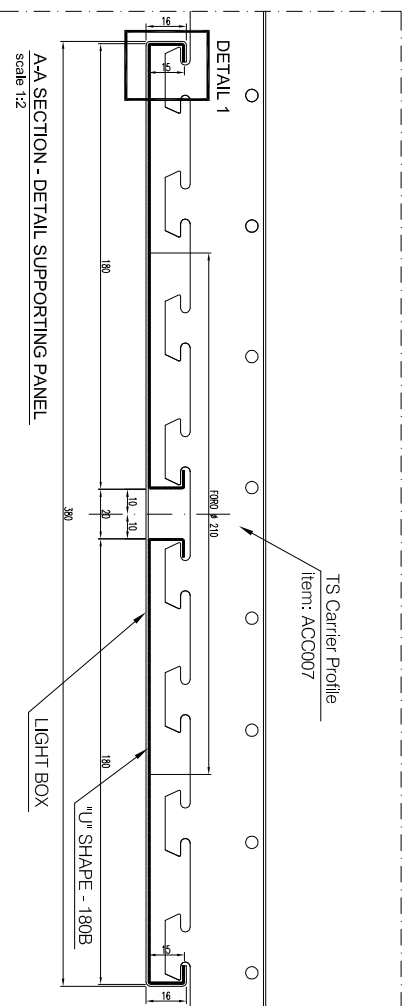

AA SECTION - DETAIL SUPPORTING PANEL
scale 1:2

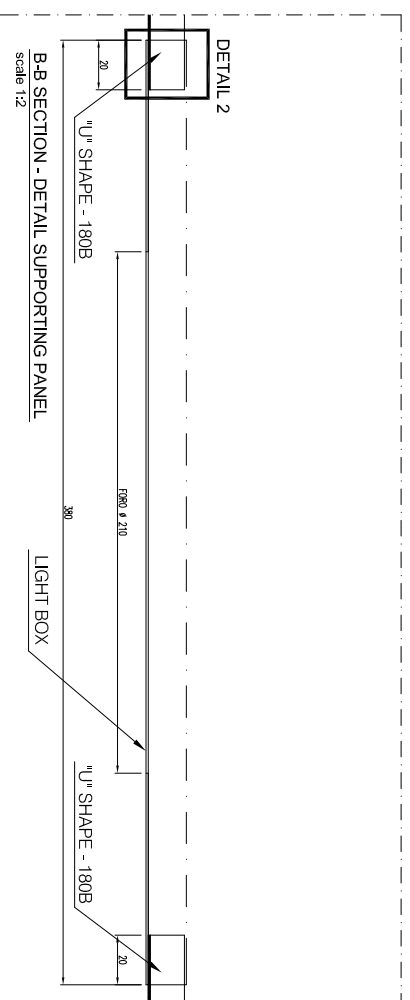

B-B SECTION - DETAIL SUPPORTING PANEL
scale 1:2

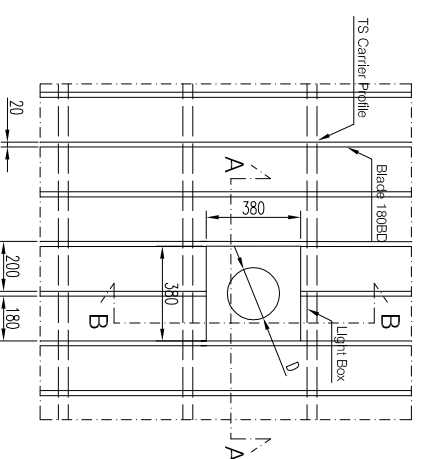

PLAN VIEW
scale 1:20

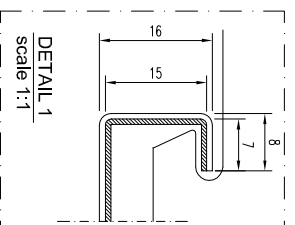

DETAIL 1
scale 1:1

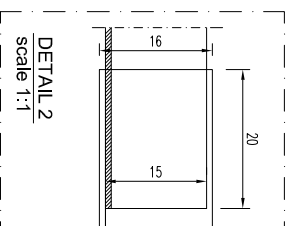

DETAIL 2
scale 1:1

REV.	DATA / DATE	DESCRIZIONE DELLE MODIFICHE / DESCRIPTION OF ALTERATIONS	Controllato Checked	Modificato Revised
Riferimento	U. TEC. BLUBUD			
Descrizione LIGHT BOX FOR BLADE 80B, 130B, 180B				
Materiale	BLUBUD srl		Scala	1:20
Material			Scale	Date
Spessore			1:20	22-06-10
Thickness				
Note	Peso netto Kg		Controllato da	Disegnato da
Notes	Net Weight Kg		Checked by	Drawn by
			P.M.	M.D.S.
Tolleranza generale			Classe prodotto	
General tolerance			Typology	
Asseni			Codice	
			ACC030	

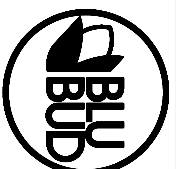

Sede operativa:
 Via Ivrea 53
 16121 Genova Italy
 Tel. +39-010 818.30.53
 Fax. +39-010 818.30.53
 e-mail: info@blubud.it
 www: http://www.blubud.it

Questo disegno non può essere usato o riprodotto senza nostra autorizzazione
 This drawing cannot be copied, duplicated or disclosed without our permission