

INSPECTION HATCHES

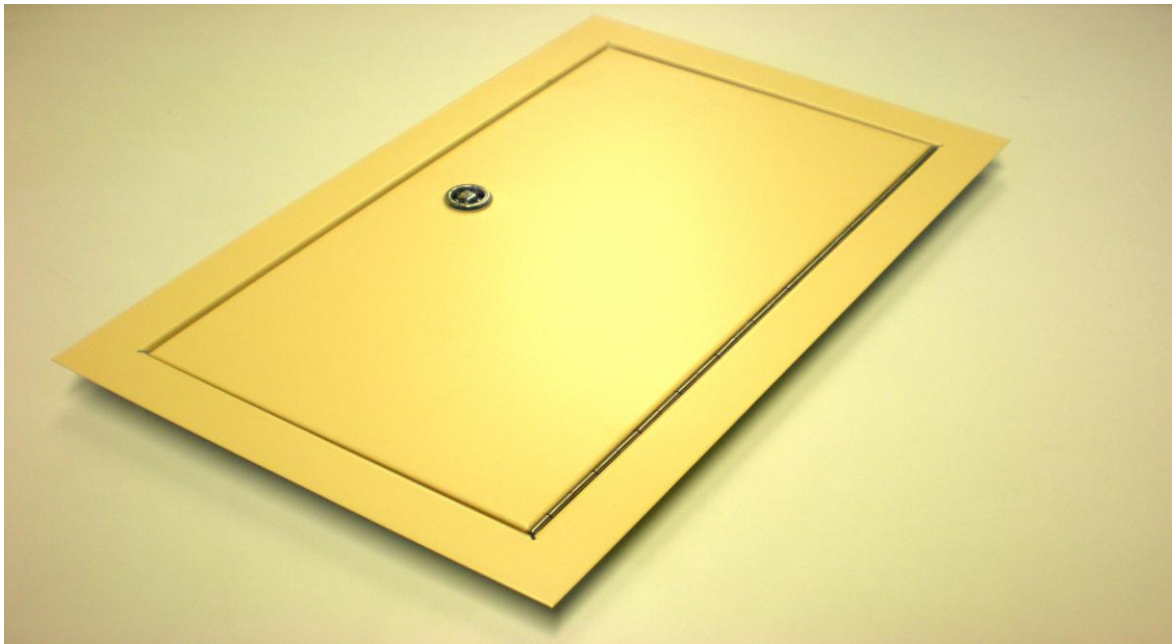

Product data sheet

General Information

description	inspection hatches for all ceiling systems
type	IH001
manufacturer	BLUBUD S.r.l

Structure

weight	0,01 kg/m ²
material	galvanized steel
finishing	rough, painted, sublimated, mirror polished
size	see dwg
thickness	2,5 mm

Use installation

for ceiling panel type	all
------------------------	-----

inspection_hatches_type_IH001_rev00

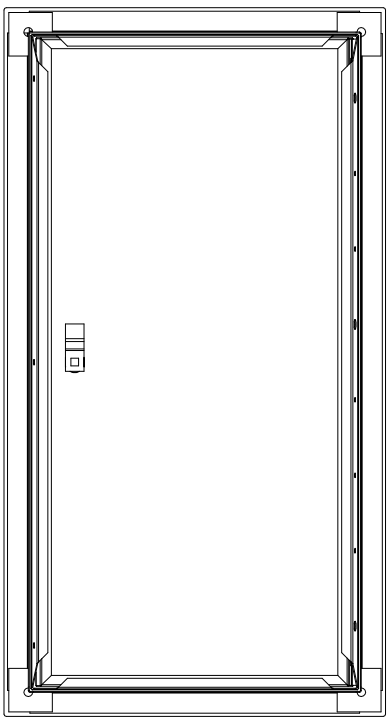
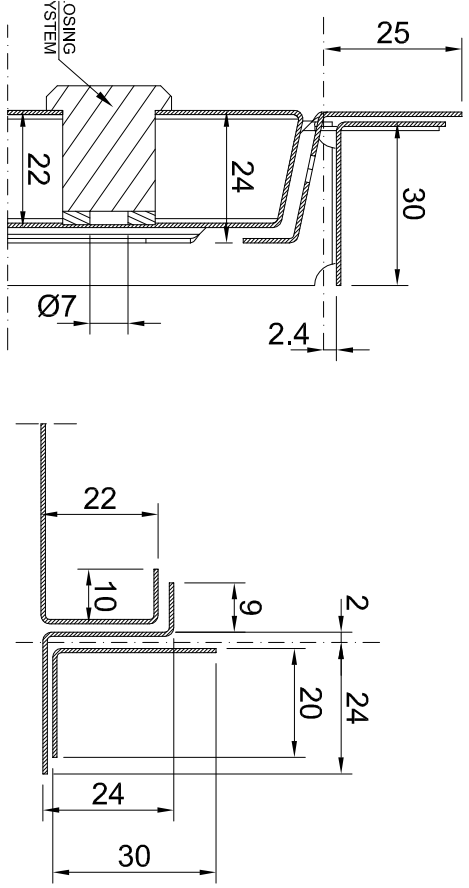
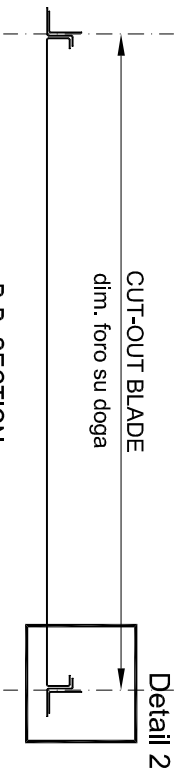
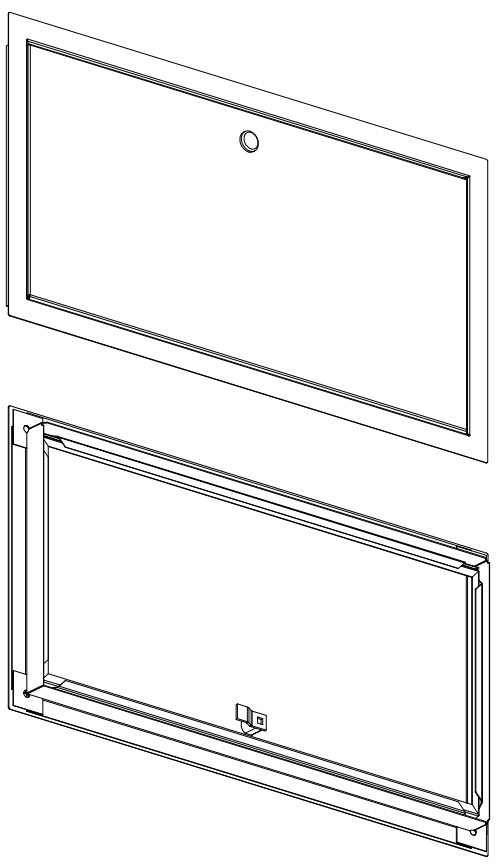
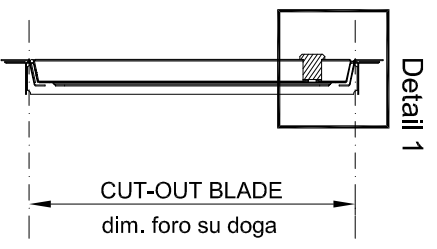
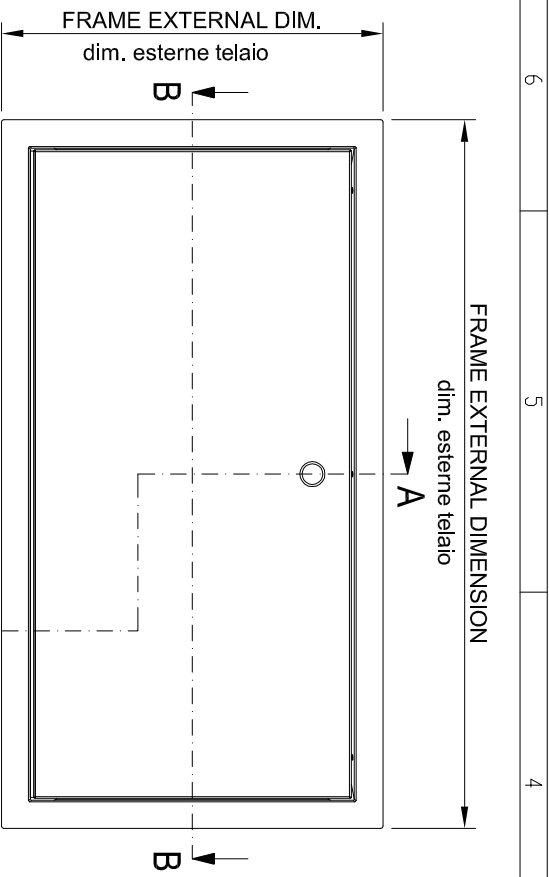

REV.	DATA / DATE	DESCRIZIONE DELLE MODIFICHE / DESCRIPTION OF ALTERATIONS	Controllato / Checked	Modificato / Revised
Riferimento / Reference	Technical Office - BLUBUD srl			
Descrizione / Description	CEILING INSPECTION HATCH - type 001			
Materiale / Material	BLUBUD srl	Scala / Scale	1:5	Data / Date
Spessore / Thickness				30-01-12
Note / Notes	Peso netto Kg / Net Weight Kg	Controllato da / Checked by	Disegnato da / Drawn by	
			M.D.S.	
Tolleranza generale / General tolerance	Assenti		Classe prodotto / Typology	
				
Questo disegno non può essere usato o riprodotto senza nostra autorizzazione This drawing cannot be copied, duplicated or disclosed without our permission				



Sede operativa:
 Via Dante 27
 10121 Genova Italy
 Tel. +39 010 89 95 55/58
 Fax. +39 010 89 95 53/57
 e-mail: info@blubud.it
 www: http://www.blubud.it